

BROCHURE 301

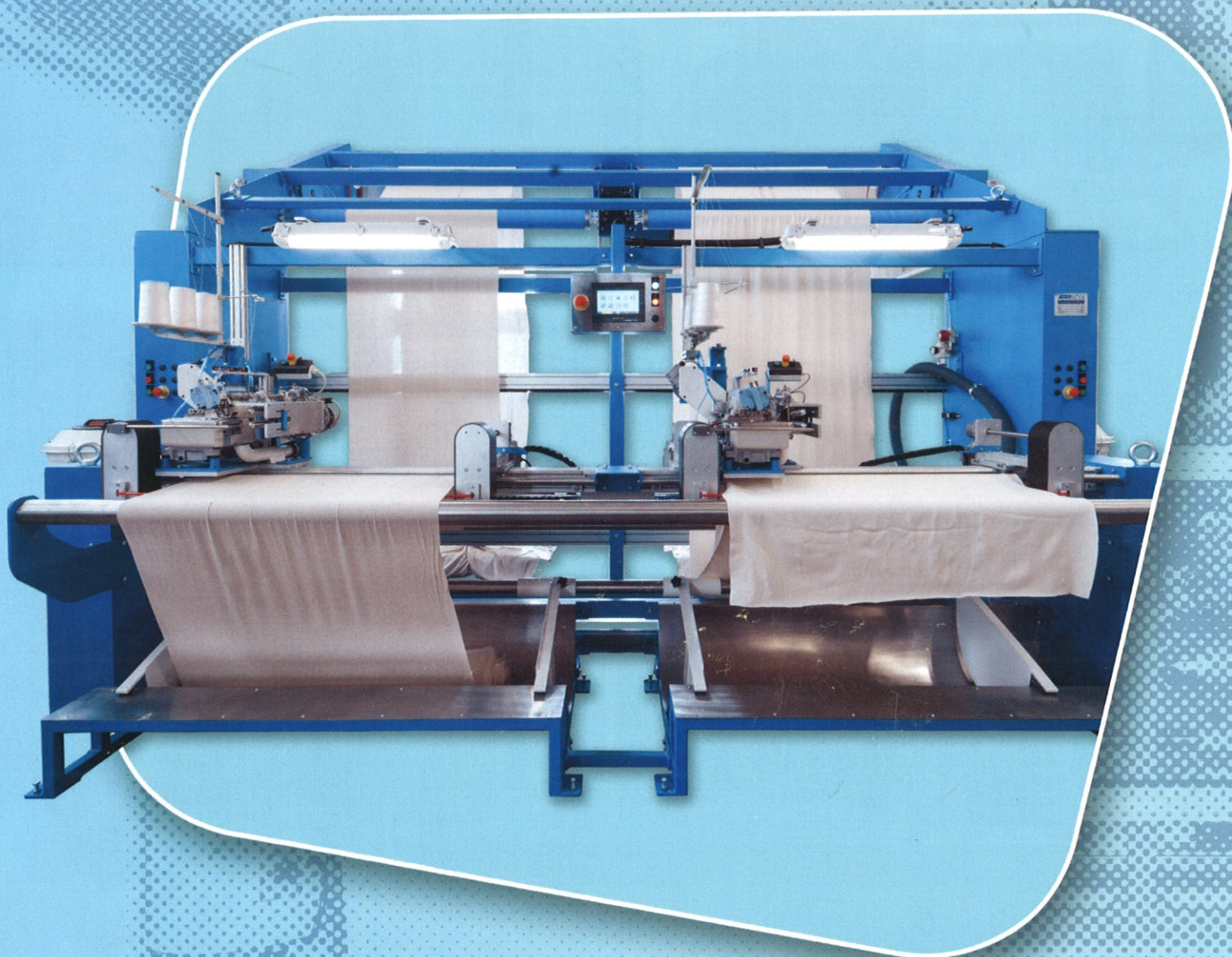

monti® **mac**
Automation since 1931

LINEA PREPARAZIONE TESSUTO GREGGIO DI MAGLIA TUBOLARE CON CICLO DI CUCITURA AUTOMATICO



**LÍNEA DE PREPARACIÓN DE TEJIDO DE PUNTO
TUBULAR CON CICLO DE COSTURA AUTOMÁTICO**

Mod. CAT 301-D-EVO



CAT301-D-EVO LAVORA IN MODO ALTERNATO DO



CAT301-D-EVO TRABAJA EN MODO ALTERNO DO

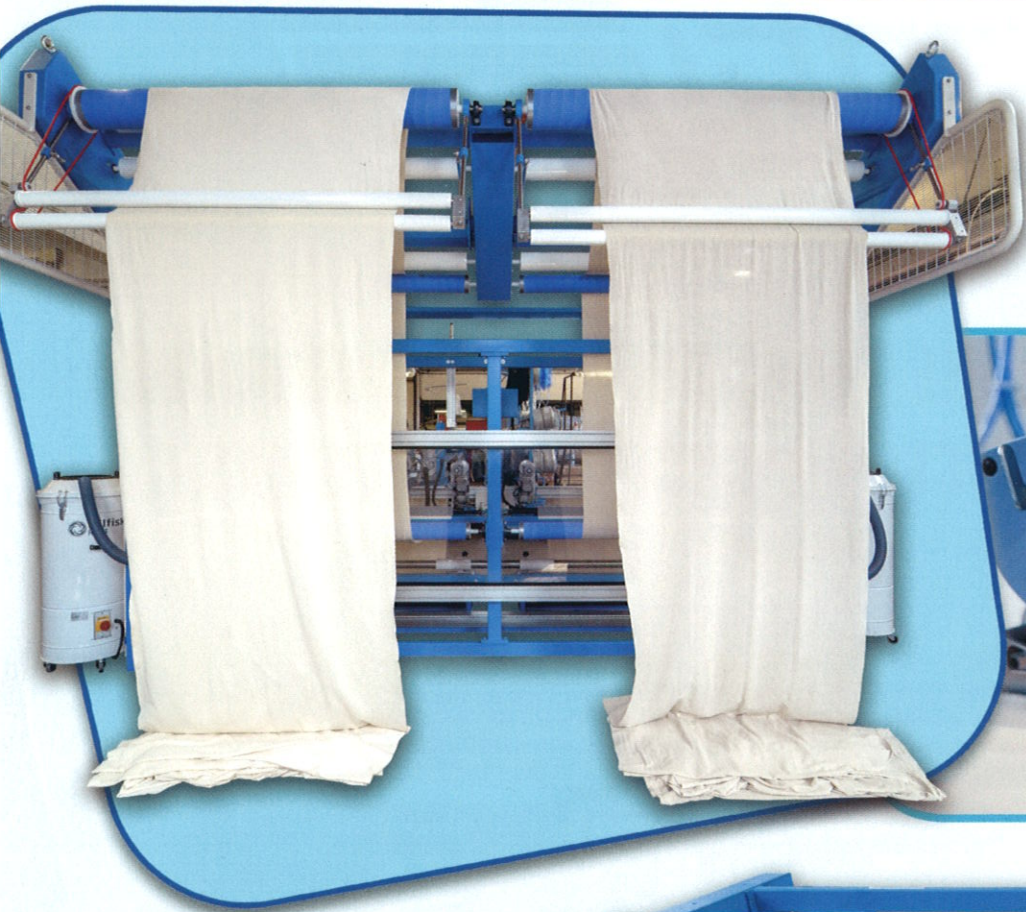

Cucitura automatica con regola-
zione ritaglio

*Costura automática con control
de desperdicio de tela*

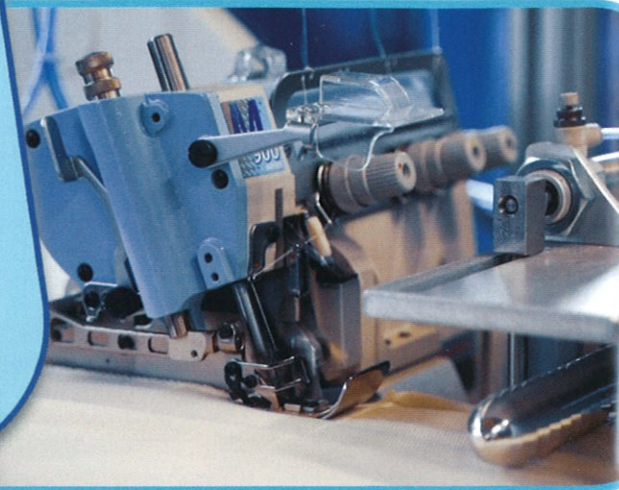

Gestione della macchina
attraverso pannello touch
7" e pulsantiera dedicata

*Gestión de máquina a tra-
vés panel táctil 7" pulgads y
botonera dedicada*

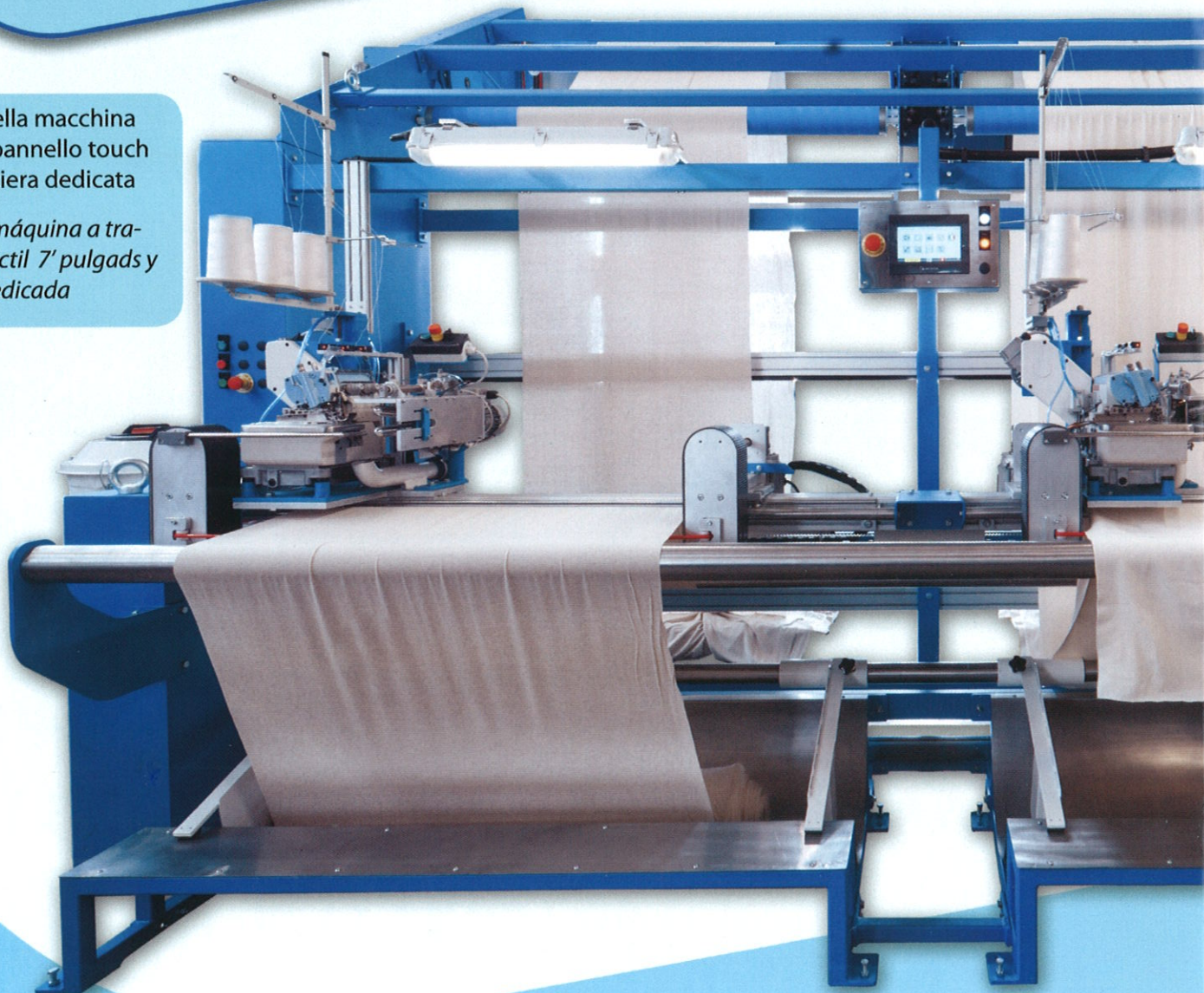

UE TUBOLARI DI TESSUTO CON 1 OPERATORE S CUERDAS DE TEJIDO EN LA MISMA MÁQUINA



MOVIMENTAZIONE AUTOMATICA DEI ROTOLI
MANIPULACIÓN AUTOMÁTICA DE ROLLOS



FACILE accesso a QUALSIASI parte della macchina da cucire
Acceso FÁCIL e INTELIGENTE a CUALQUIER pieza
de la máquina de coser

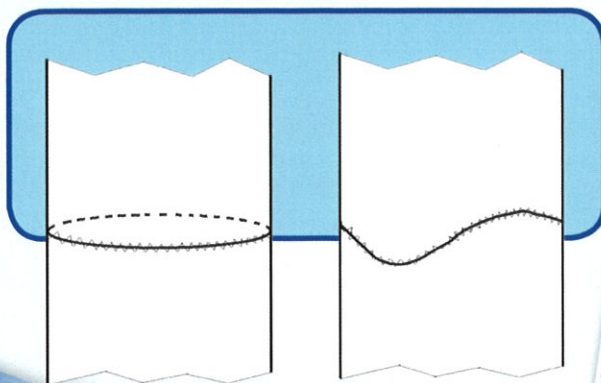

La cucitura lineare
diventa una certezza
Costura lineal se convierte
en una certeza

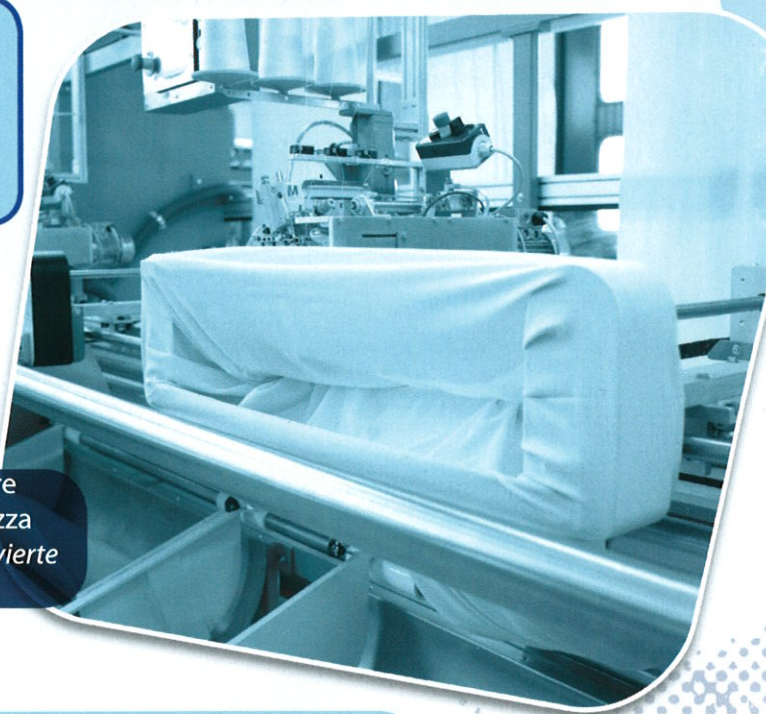

Portatessuto in cucitura a mezzo 2 nastri
motorizzati a posizione variabile in funzio-
ne del diametro del tubolare

Porta tejido a través 2
correas motorizadas con
posición variable según
diámetro del tubolar



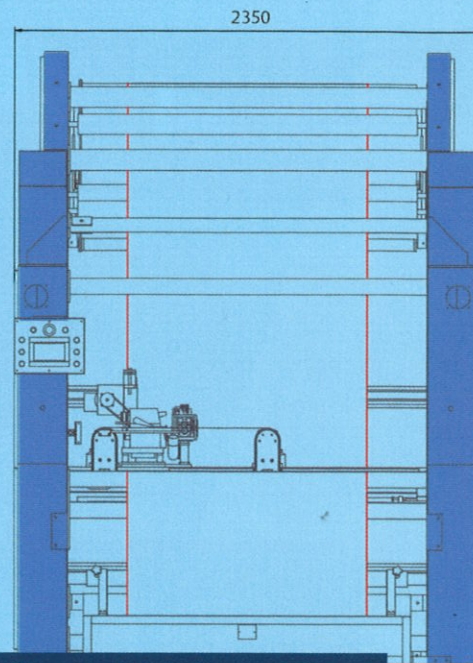
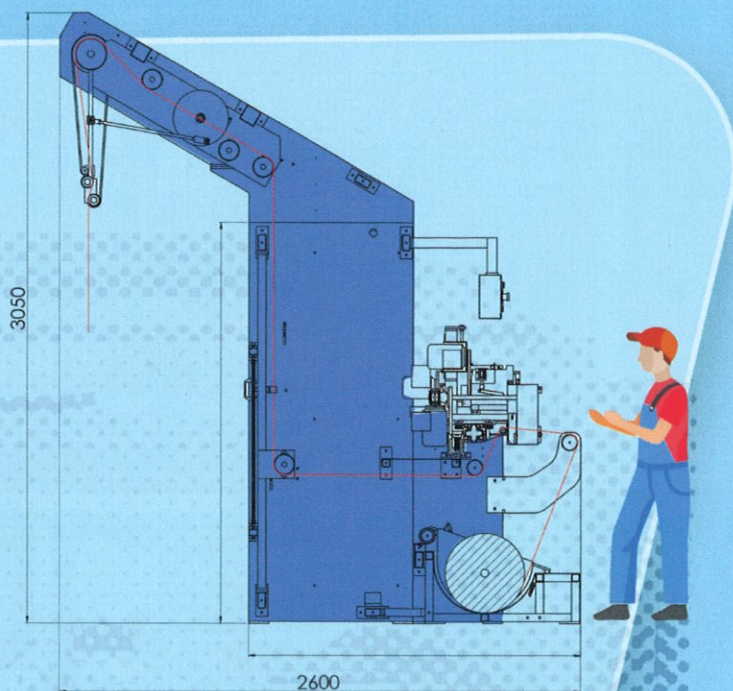

Mod. CAT 301-S-EVO

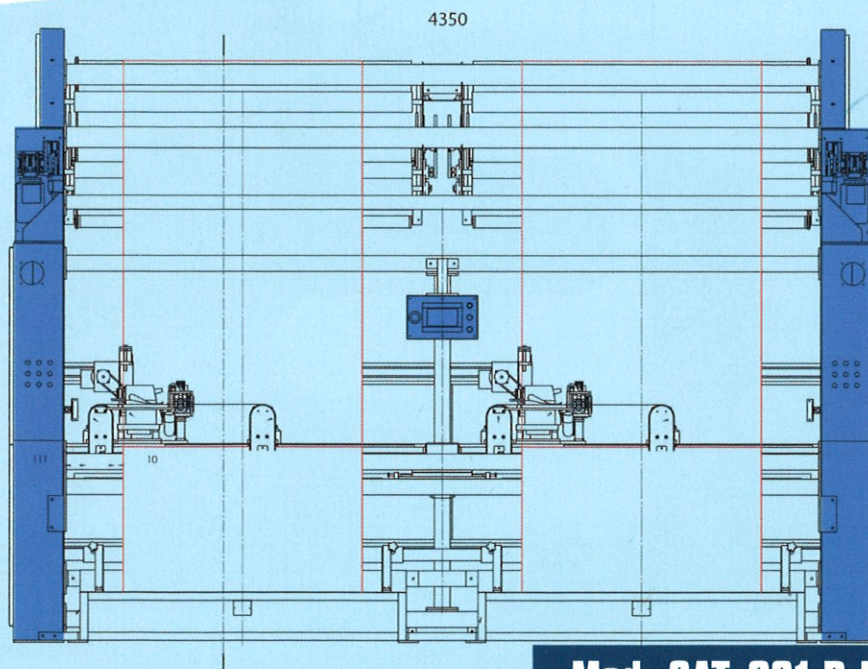

Mod. CAT 301-D-EVO



Macchine da cucire speciali e impianti di cucitura per l'industria tessile

VIA REPUBBLICA, 11 — 22075 LURATE CACCIVIO (COMO) ITALY

TEL. +39 031 390 655 — FAX +39 031 390 095 — www.montimac.it — E-mail: info@montimac.it